

RESMED

Mirage Activa™ LT

NASAL MASK

User Guide

English



Mirage Activa LT

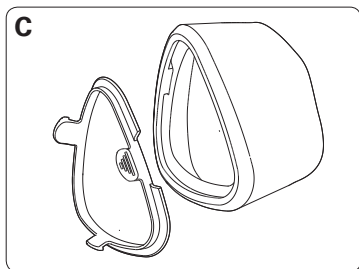
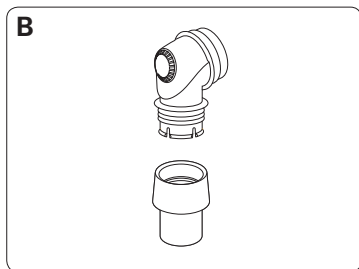
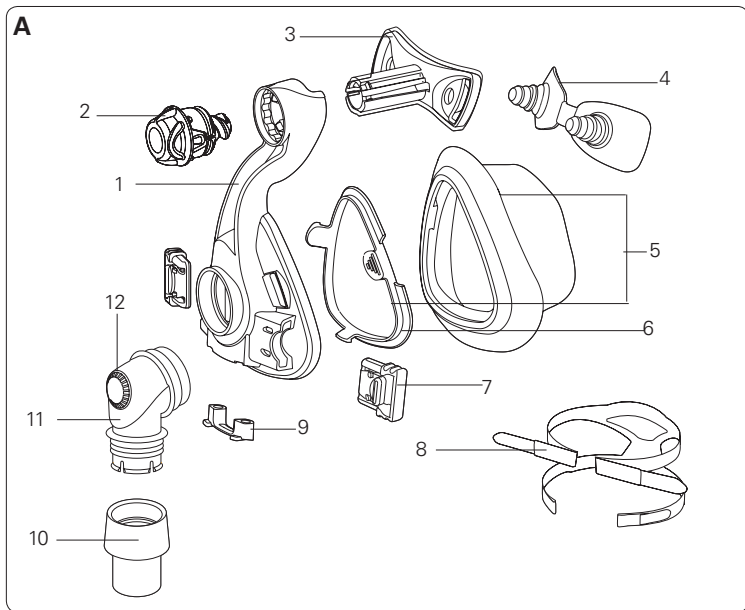

Mask components / Maskenkomponenten / Composants du masque / Componenti della maschera

Item / Artikel / Article / Articolo / Artikel	Description / Beschreibung / Description / Descrizione / Beschrijving	Part number / Artikelnummer / Code produit / Numero parte / Onderdeelnummer	
1	Mask frame / Maskenrahmen / Entourage rigide / Telaio della maschera / Maskerframe	60180 (St) 60193 (S)	
2	Dial / Drehregler / Molette de réglage / Selettore di regolazione / Draaiknop	61289	
3	Forehead support / Stirnstütze / Support frontal / Supporto frontale / Voorhoofdsteun	16393	
4	Forehead support pad / Stirnpolster / Tampon frontal / Imbottitura del supporto frontale / Kussentje van voorhoofdsteun	60123 (1) 60124 (10)	
5	Activa LT Cushion & clip / Maskenkissen und Clip / Bulle et clip / Cuscinetto e fermaglio / Kussentje en klem	60198 (S) 60177 (M) 60178 (L) 60179 (LW)	
6	Cushion clip / Maskenkissen-Clip / Clip de la bulle / Fermaglio del cuscinetto / Klem voor kussentje	60176 (St) 60197 (S)	
7	Headgear clip / Kopfband-Clip / Clip d'attache du harnais / Fermaglio del copricapo / Hoofdbandklem	16569 (2) 16734 (10)	
8	Headgear / Kopfband / Harnais / Copricapo / Hoofdband	16118 (S) 16117 (M) 16119 (L)	
9	Ports cap / Anschlusskappe / Bouchon d'entrées / Coperchio delle prese / Poortkap	16570 (2) 16571 (10)	
10	Swivel / Drehadapter / Pièce pivotante / Giunto rotante / Draaibare kop	16565	
11	Elbow / Kniestück / Coude / Gomito / Bocht	16387	
12	Vent / Luftauslassöffnung / Orifice de ventilation / Foro per l'esalazione / Ventilatieopening	—	
A	Complete system / Komplettes System / Masque complet / Maschera con tutti i componenti / Volledig systeem	EUR1	APAC
		60186 (S)	60212 (S)
		60151 (M)	60213 (M)
		60152 (L)	60214 (L)
		60153 (LW)	60215 (LW)

B	Elbow assembly / Kniestück mit Drehadapter / Coude / Complesso del gomito / Complete bocht	16399
Also available / Außerdem erhältlich / Également disponible / Altri prodotti		
C	SoftGel Cushion & clip / Maskenkissen und Clip / Bulle et clip / Cuscinetto e fermaglio / Kussentje en klem	61631 (S) 61632 (M) 61633 (L) 61634 (LW)

S Small / Small / Petit / Small / Small

M Medium / Medium / Médium / Medium / Medium

L Large / Large / Grand / Large / Large

LW Large Wide / Large Wide / Large Wide / Grande larga / Large Wide

St Standard / Standard / Standard / Standard / Standaard

Fitting / Anlegen / Mise en place / Applicazione

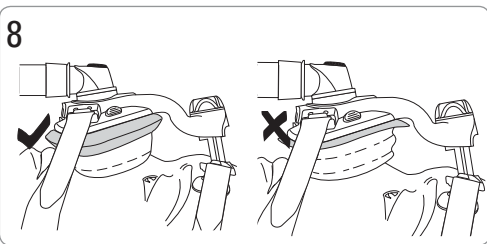
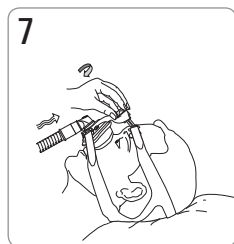
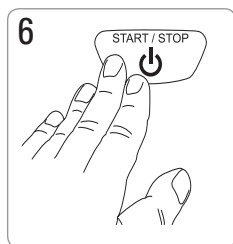
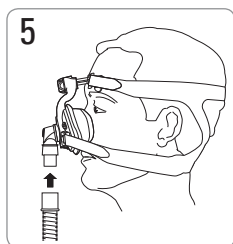
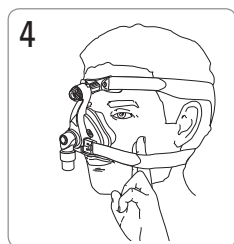
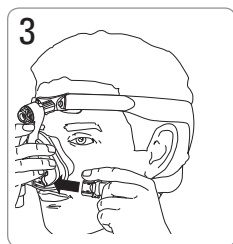
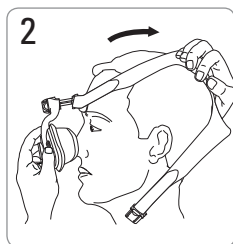
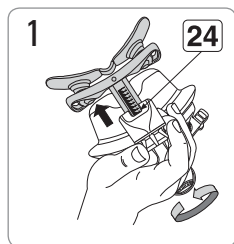

**Removal / Abnehmen der Maske / Retrait /
Rimozione della maschera**

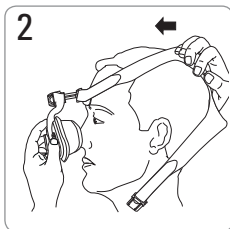
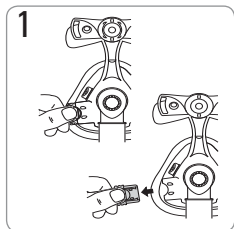

Disassembly / Auseinanderbau / Démontage / Smontaggio

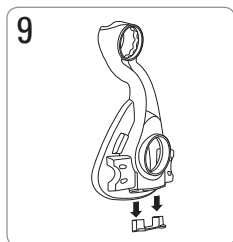
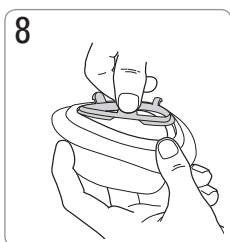
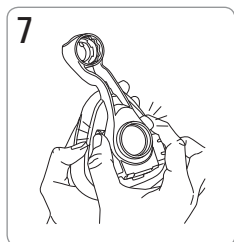
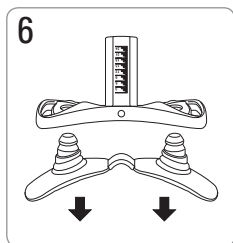
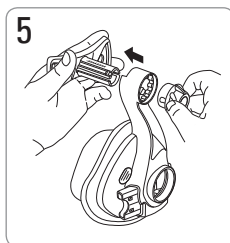
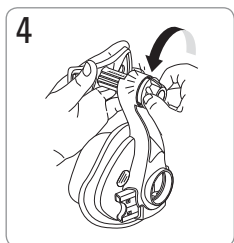
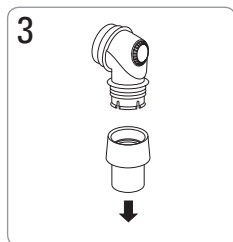
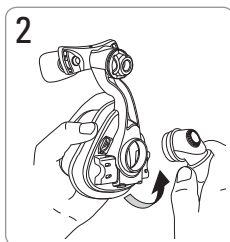
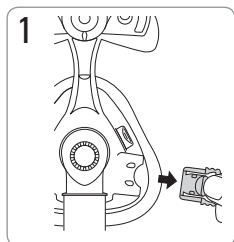

Reassembly

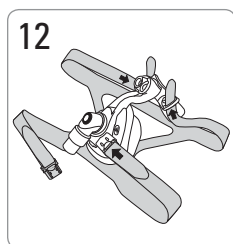
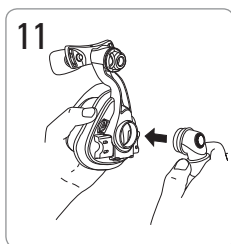
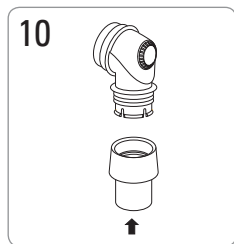
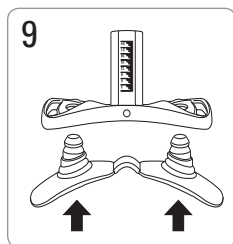
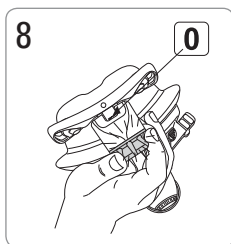
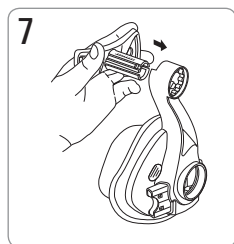
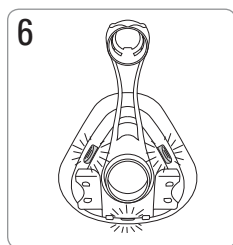
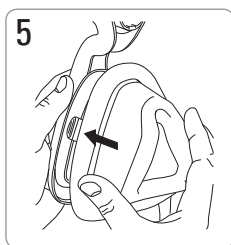
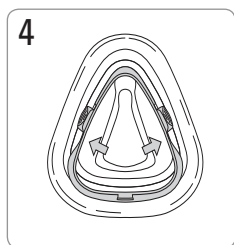
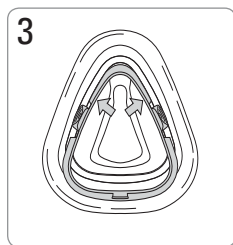
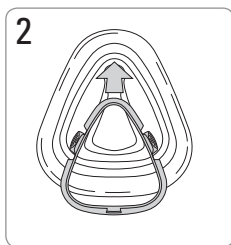
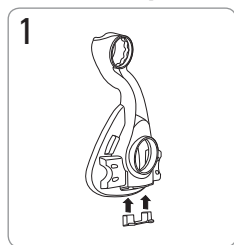

Mirage Activa™ LT

NASAL MASK

Thank you for choosing the Mirage Activa™ LT. The Mirage Activa LT is the first of ResMed's masks offering a choice of two high performance cushions (Mirage Activa LT and Mirage SoftGel) on the one durable frame. For further information, refer to the Mirage SoftGel User Information section in this User Guide.

Intended Use

The Mirage Activa LT channels airflow noninvasively to a patient from a positive airway pressure device such as a continuous positive airway pressure (CPAP) or bilevel system.

The Mirage Activa LT is:

- to be used by adult patients (>30 kg) for whom positive airway pressure has been prescribed
- intended for single-patient re-use in the home and multipatient re-use in the hospital/institutional environment.

Using your mask

When using your mask with ResMed CPAP or bilevel devices that have mask setting options, refer to the Technical specifications section in this user guide for mask selection options.

For a full list of compatible devices for this mask, see the Mask/Device Compatibility List on www.resmed.com on the **Products** page under **Service & Support**. If you do not have internet access, please contact your ResMed representative.



WARNING

- The vent holes must be kept clear.
- Follow all precautions when using supplemental oxygen.
- Oxygen flow must be turned off when the flow generator is not operating, so that unused oxygen does not accumulate within the flow generator enclosure and create a risk of fire.
- At a fixed flow rate of supplemental oxygen flow, the inhaled oxygen concentration varies, depending on the pressure settings, patient breathing pattern, mask, point of application and leak rate.

- The technical specifications of the mask are provided for your clinician to check that they are compatible with the flow generator. If used outside specification or if used with incompatible devices, the seal and comfort of the mask may not be effective, optimum therapy may not be achieved, and leak, or variation in the rate of leak, may affect the flow generator function.
- Discontinue using the mask if you have ANY adverse reaction to the use of the mask, and consult your physician or sleep therapist.
- Using a mask may cause tooth, gum or jaw soreness or aggravate an existing dental condition. If symptoms occur, consult your physician or dentist.
- As with all masks, some rebreathing may occur at low CPAP pressures.
- Refer to your CPAP or bilevel device manual for details on settings and operational information.
- Remove all packaging before using the mask.

Cleaning your mask in the home

Your mask and headgear should only be handwashed by gently rubbing in warm (approximately 30°C) water using mild soap. All components should be rinsed well with drinking quality water and allowed to air dry out of direct sunlight.

Daily/After each use:

- To optimise the mask seal, facial oils should be removed from the cushion after use.
- Handwash the separated mask components (excluding headgear).
- If the vent requires cleaning use a soft bristle brush.

Weekly:

- Handwash the headgear. It may be washed without being disassembled.



WARNING

Do not use aromatic-based solutions or scented oils (eg, eucalyptus or essential oils), bleach, alcohol or products that smell strongly (eg, citrus) to clean any of the mask components. Residual vapors from these solutions can be inhaled if not rinsed thoroughly. They may also damage the mask, causing cracks.



CAUTION

- If any visible deterioration of a mask component is apparent (cracking, crazing, tears etc.), the mask component should be discarded and replaced.
- Avoid connecting flexible PVC products (eg, PVC tubing) directly to any part of this mask. Flexible PVC contains elements that can be detrimental to the materials of the mask, and may cause the components to crack or break.

Reprocessing the Mask between Patients

This mask should be reprocessed when used between patients. Cleaning, disinfection and sterilisation instructions are available from the ResMed website, www.resmed.com/masks/sterilization.

If you do not have Internet access, please contact your ResMed representative.

Troubleshooting

Possible reason

Solution

Mask is uncomfortable

Headgear straps are too tight.

Adjust the straps evenly. The forehead support “anchors” your mask and should sit firmly on your forehead.

Cushion incorrectly inflated.

With the air turned off, adjust the straps so that you can insert two fingers between your cheek and the lower headgear strap.

Mask is too noisy

Cushion clip is not inserted correctly.

Check that the cushion clip is correctly inserted into the cushion, and that the cushion is correctly clipped to the frame.

Ports cap or elbow incorrectly inserted.

Check the the ports cap and elbow are correctly inserted.

Vents are blocked or partially blocked.

Clean vents according to instructions in “Cleaning the Mask at Home”.

Air leaking around the face

Mask not positioned correctly.

Reposition the mask upon the face.

Air leaking around the bridge of the nose.

Wind the dial in.

Air leaking around the top of the lip.

Wind the dial out.

The mask does not fit properly

Cushion could be the wrong size.

Talk to your clinician.

Mask is incorrectly assembled.

Reassemble the mask according to the instructions in “Reassembly”.

Cushion may be dirty.

Clean cushion according to instructions in “Cleaning the Mask at Home”.

Cannot insert forehead support into mask frame

When assembling the mask, you have inserted the dial into the frame before the forehead support.

Push dial base onto a hard surface until the dial comes out of the frame.

Technical Specifications

Pressure-Flow Curve

The mask contains passive venting to protect against rebreathing. As a result of manufacturing variations, the vent flow rate may vary.

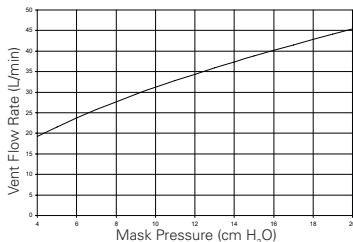

Pressure (cm H ₂ O)	Flow (L/min)
4	19
8	28
12	34
16	40
20	45

Dead Space Information

The dead space of the mask varies according to cushion size. It is 185 mL for the Medium size.

Therapy Pressure

4 to 20 cm H₂O

Environmental Conditions

Operating temperature: +5°C to +40°C
 Operating humidity: up to 95% non-condensing
 Storage and transport temperature: -20°C to +60°C
 Storage and transport humidity: up to 95% non-condensing

Resistance

Drop in pressure measured (nominal)
 at 50 L/min: 0.1 cm H₂O
 at 100 L/min: 0.7 cm H₂O

Sound

DECLARED DUAL-NUMBER NOISE EMISSION VALUES in accordance with ISO 4871. The A-weighted sound power level of the mask is 30 dBA, with uncertainty 3 dBA. The A-weighted sound pressure level of the mask at a distance of 1m is 22 dBA, with uncertainty 3 dBA.

Gross dimensions

S: 141 mm (H) x 91 mm (W) x 107 mm (D)
 M, L, LW: 154 mm (H) x 95 mm (W) x 117 mm (D)
 Mask fully assembled – no headgear.

Mask setting options

Select 'Activa' (if available) otherwise select 'Standard' as the mask option.

Notes:

- The mask system does not contain PVC or DEHP materials.
- This product does not contain natural rubber latex.
- The manufacturer reserves the right to change these specifications without notice.

Storage

Ensure that the mask is thoroughly clean and dry before storing it for any length of time. Store the mask in a cool dry place out of direct sunlight.

Disposal

The mask does not contain any hazardous substances and may be disposed of with your normal household refuse.

Symbols

 Caution, consult accompanying documents;  Batch Code;  Catalogue Number;  European Authorised Representative;  Temperature limitation;  Humidity limitation;  Does not contain natural rubber latex;  Manufacturer;  Indicates a Warning or Caution and alerts you to a possible injury or explains special measures for the safe and effective use of the device.  Keep away from rain;  This way up;  Fragile, handle with care.

Consumer Warranty

ResMed acknowledges all consumer rights granted under the EU Directive 1999/44/EG and the respective national laws within the EU for products sold within the European Union.

RESMED

Mirage™ SoftGel

NASAL MASK / NASENMASKE / MASQUE NASAL /
MASCHERA NASALE

User information

English • Deutsch • Français • Italiano

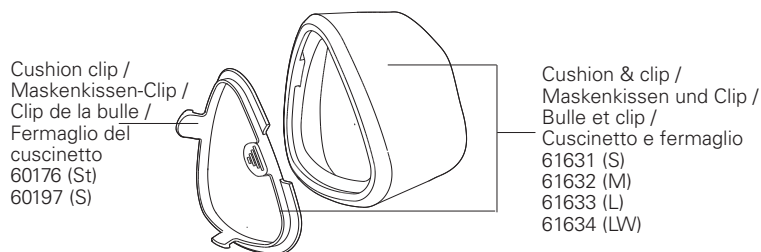

Please read this information in conjunction with your Mirage Activa™ LT User Guide when changing your Mirage Activa LT cushion to the Mirage SoftGel cushion.

Intended use

The Mirage SoftGel channels airflow noninvasively to a patient from a positive airway pressure device such as a continuous positive airway pressure (CPAP) or bilevel system.

The Mirage SoftGel is:

- to be used by adult patients (> 30 kg) for whom positive airway pressure has been prescribed
- intended for single-patient re-use in the home environment and multipatient re-use in the hospital/institutional environment.

Troubleshooting

Problem/possible cause	Solution
------------------------	----------

Mask is uncomfortable

Headgear straps are too tight.	Adjust straps evenly. The forehead support 'anchors' your mask and should sit firmly on your forehead.
Fit is too tight.	Wind out dial.

Technical specifications

Dead space information	Physical dead space is the empty volume of the mask to the end of the swivel. Using the large cushions it is 145 mL.
Sound	DECLARED DUAL NUMBERED NOISE EMISSION VALUES IN ACCORDANCE WITH ISO 4871 The A weighted sound power level of the mask is 29 dBA, with uncertainty 3 dBA. The A-weighted sound pressure level of the mask at a distance of 1 m is 22 dBA, with uncertainty 3 dBA.
Resistance	Drop in pressure measured (nominal) at 50 L/min: 0.3 cm H ₂ O at 100 L/min: 0.9 cm H ₂ O
Gross dimensions	Mask fully assembled - no headgear S 141 mm (H) x 91 mm (W) x 107 mm (D) M, L, LW: 155 mm (H) x 91 mm (W) x 118 mm (D)
Mask setting options	Select 'ACTIVA' (if available), otherwise select 'STANDARD' as the mask option.

**Fitting and assembly / Anpassung und Zusammenbau /
Ajustement et montage / Applicazione e assemblaggio**

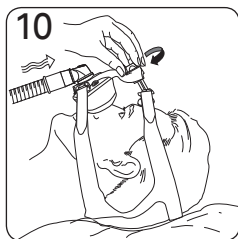
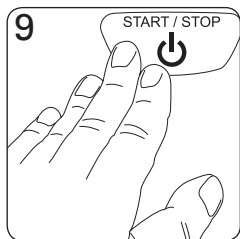
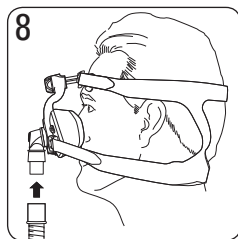
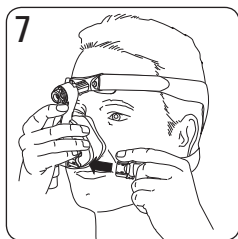
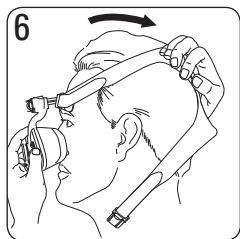
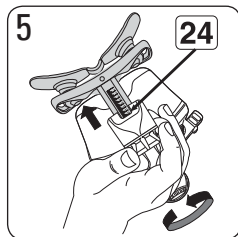
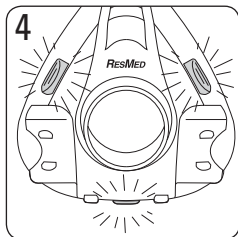
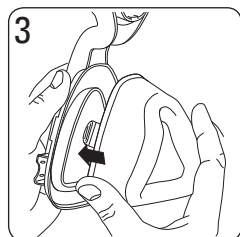
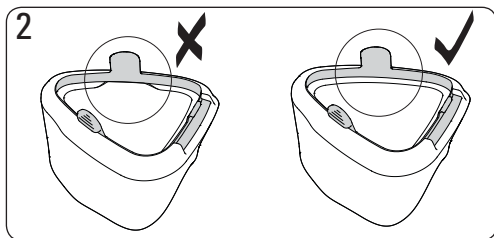
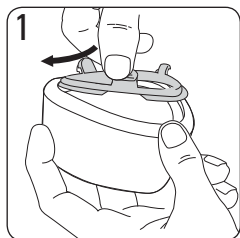



Manufacturer:

ResMed Ltd 1 Elizabeth Macarthur Drive Bella Vista NSW 2153 Australia

Distributed by:

ResMed Corp 9001 Spectrum Center Boulevard San Diego CA 92123 USA

ResMed (UK) Ltd 96 Milton Park Abingdon Oxfordshire OX14 4RY UK

See www.resmed.com for other ResMed locations worldwide.



For patent information, see www.resmed.com/ip

Mirage and Activa are trademarks of ResMed Ltd and are registered in U.S. Patent and Trademark Office.

© 2012 ResMed Ltd.





608333/1 2012-01
MIRAGE ACTIVA LT
USER
EUR 1 - ENG



608333